

FEATURED MODEL

514-483 9" & 9" bowl depths

ADDITIONAL MODELS

511-577 10" & 10" bowl depths

511-620 8" & 8" bowl depths

FEATURES

- 18 gauge, 304 series stainless steel
- 18/10 chrome/nickel content
- Long-lasting, easy-to-clean, satin polished finish
- Rear drain placement

CODE/STANDARDS COMPLIANCE

ASME 112.19.3-00
 IAPMO/UPC listed

OPTIONAL ACCESSORIES

Sink Grid: 220-993 (Formerly 510-902)
 Colanders: 215-651

WARRANTY

Blanco America's Platinum Series sinks feature a "NO HASSLE" LIMITED LIFETIME WARRANTY to be free of all manufacturing defects under normal use. See our complete warranty for details.

While Blanco America endeavors to provide accurate information, all dimensions are nominal, cannot be guaranteed, and are subject to change or cancellation. Blanco America assumes no responsibility for use of superseded or voided specifications.

PRODUCT SPECIFICATION

Undermount sink to be equal double bowl design, 32" in length and 20-7/8" in front-to-back depth. Sink to be made from 18 gauge, 304 series stainless steel, with 18/10 chrome/nickel content and satin polished finish. Sink to feature rear drain placement. Sink to be Blanco Model 514-483, with left bowl depth of 9" and right bowl depth of 9". This sink is meant for a single-post mount faucet application.



MODEL 514-483

NOMINAL DIMENSIONS

MODEL	OVERALL	CUTOUT SIZE	BOWL DEPTH LEFT	BOWL DEPTH RIGHT	DRAIN DIAMETER
514-483	32 x 20-7/8	Template provided with approximate 1/8" reveal	9	9	3-1/2

DXF cutout templates available on our web site.

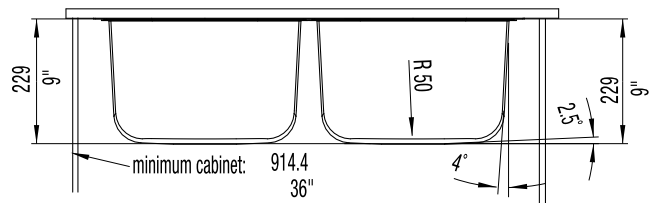
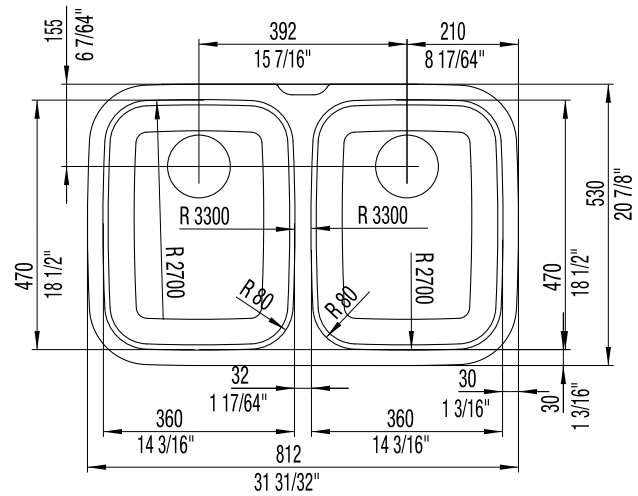

JOB INFORMATION

Job Name: _____
 Contact: _____
 Date Specified: _____
 Specifier: _____
 Contractor: _____